



NAVISTAR

PROVING GROUNDS

ADDRESS

32104 IN-2,
New Carlisle, IN 46552

CONTACT

(574) 654-2400

navistar.com/proving-grounds



ABOUT US

The Navistar Proving Grounds operates as an independent vehicle-testing facility and is a wholly owned operating department of Navistar, Inc.

675 Acres of Rolling Countryside

It is located on 675 acres of rolling countryside in New Carlisle, IN, approximately 12 miles west of South Bend. The NPG provides a safe, secure and comprehensive vehicle-testing and development environment available to all vehicle, component, and related automotive-industry manufacturers and component suppliers.

Our Dedication

NPG recognizes the proprietary and confidential nature of our clients' activities and is dedicated to maintaining and enforcing policies designed to provide necessary vehicle and program security.

OUR HISTORY

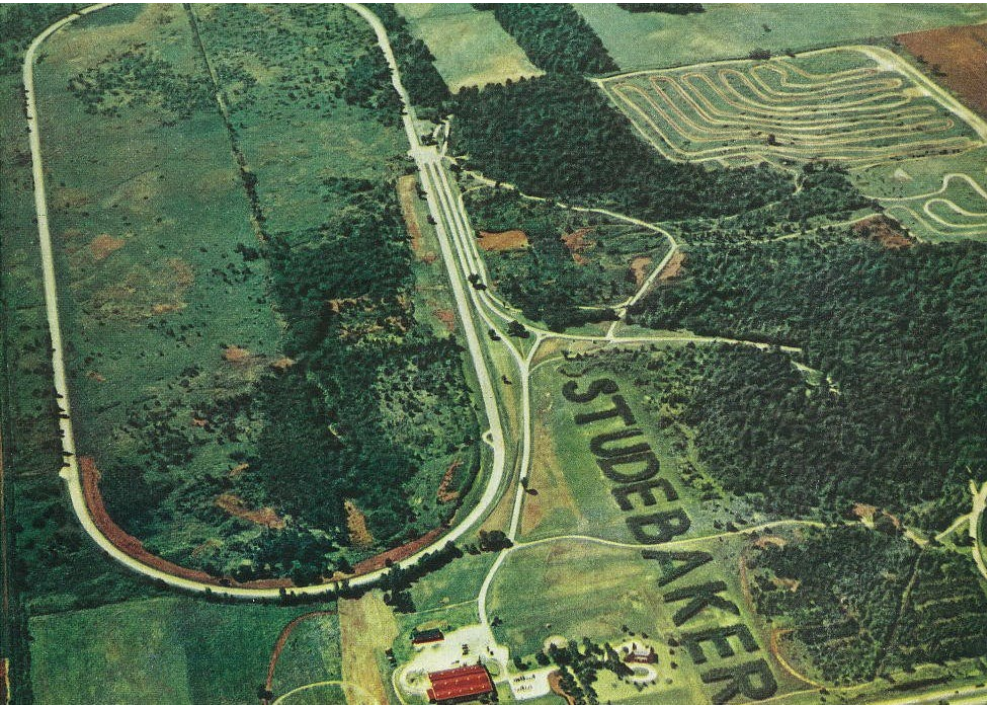

In the early **1960s**, the Bendix Corporation became aware of the competitive advantage that a private test facility could provide a supplier to the automotive industry.

In December 1963, the Studebaker Corporation, which originally constructed the proving grounds in 1926, shut down production in South Bend. After a three-year lease arrangement, Bendix purchased the proving grounds in 1966, and the BAPG tradition began.

The Bendix Corporation, under a merger, became part of Allied Corporation, which later became AlliedSignal, Inc. In 1996, Robert Bosch GmbH of Stuttgart, Germany, purchased AlliedSignal's worldwide automotive brake business, including the proving grounds. In 2014, Navistar, Inc. purchased the Proving Grounds from Robert Bosch.

FACILITIES



NPG provides a complete brake-test facility:

Garage facilities for both light vehicles and heavy vehicles (RV, military, tractor-trailer, buses, and construction equipment). Facilities include hoists, scales, alignment equipment, ballast and machine shop.

Test Personnel

NPG has trained personnel skilled in the various areas required to support vehicle brake system testing:

- Technicians experienced with vehicle mechanical build-up and instrumentation.
- Performance drivers experienced with getting the maximum performance out of both light and heavy vehicles.
- Engineers experienced with customer-program coordination, test supervision, data analysis, problem solving and test-report generation.

ACCELERATED STRUCTURAL

DURABILITY TESTING

VEHICLE TYPES

Structural-durability testing experience with the following vehicle types:

- Passenger cars/light trucks
- Heavy trucks (straight trucks and tractors)
- Buses and motor coaches
- Recreational vehicles (motor homes, travel trailers)
- Commercial trailers (van, flatbed, tank, and container chassis)
- Military vehicles
- School buses
- Medium-duty commercial trucks
(e.g., delivery trucks, ambulances, fire trucks)



DURABILITY TESTING

DURABILITY EVENTS

A variety of durability events

- **Multiple road surfaces**
chatter, impact, cobblestone, undulating, resonance road, high-speed oval, gravel, body/chassis twist event, off road surfaces
- Durability route and mileage amounts tailored to specific customer needs
- Gravel surfaces also are available for ABS evaluation.

SUPPORT SERVICE

Complete vehicle structural-durability support services:

- Road-profile capability (real-world correlation to a NPG durability course using accelerometer and strain-gage data)
- 24-hour-per-day mileage accumulation provided
- 7-day-per-week mileage accumulation available.
- Data-acquisition systems and instrumentation available
- Ballast (load simulation) provided as required.
- NPG-road or public-road mileage accumulation available

PERSONNEL

Trained personnel skilled in supporting vehicle structural-durability testing

- Technicians experienced in initial inspections, vehicle build-up, ballast installation, in-test inspections and vehicle repairs.
- Mileage-accumulation drivers
- Engineers experienced in coordinating durability mileage-accumulation programs, route selection road-profile determination, data analysis and test-report preparation.

ADDITIONAL VEHICLE TESTING CAPABILITIES

POWER TRAIN-DURABILITY TESTING

On-track power train-durability testing experience with both passenger cars and light-/medium-duty trucks.

- Mileage-accumulation route tailored to specific customer needs
- 24-hour-per-day mileage accumulation provided
- 6- and 7-day-per-week mileage accumulation available
- Off ground mileage accumulation available
- Data acquisition/instrumentation available
- Ballast provided as required
- NPG oval-track or public-road mileage-accumulation course available
- Cold-weather mileage accumulation available
- Storage for special fuels

Trained personnel experienced in supporting power train-durability testing:

- Technicians
- Drivers
- Test-program coordinators

VEHICLE NOISE TESTING

SAE J336, SAE J1470, EPA pass-by (Title 40, part 205), etc. interior and exterior

VEHICLE HANDLING

- Three-mile banked oval (three lanes wide)
- Vehicle-dynamics area one, measuring 300 feet by 1400 feet
- Vehicle -dynamics area two, measuring 550 feet by 530 feet plus re-entry lane for establishing test maneuver speeds, total length 1375 feet.
- Experienced performance drivers available

CENTER-OF-GRAVITY DETERMINATION

Vertical and longitudinal CG locations determined by lifting vehicle and measuring weight transfer

VEHICLE ROLLOVER-PROTECTION TEST

SAE J336, SAE J1470, EPA pass-by (Title 40, part 205), etc. interior and exterior



ADDITIONAL VEHICLE TESTING CAPABILITIES



FUEL ECONOMY TESTING

SAE J1526, etc. on 3 mile oval track and off grounds

DATA-ACQUISITION CAPABILITY

- Strain, acceleration, force, pressure, temperature, displacement, velocity, torque
- Data-acquisition systems available
- All instrumentation is calibrated per ISO TS 16949 procedures.

TYPICAL MEASUREMENTS

Stopping Distance
Deceleration
Stop Time
Wheel Speed
Wheel Torque
Brake Temperature
Brake Pressure

Vibration
Strain Gages
Pedal Force
Pedal Travel
Engine Vacuum
Center of Gravity
Interior and Exterior

VEHICLE FORDING CAPABILITY

Evaluation of vehicles traversing water up to depths of 84 inches.

GRADEABILITY

Ability of vehicles to ascend or hold on various grades up to 60%.

TRACTION-CONTROL EVALUATION

Low-coefficient surfaces on level ground, 12% and 20% grades.

TESTING FACILITIES

HIGH-SPEED OVAL TRACK

The three-mile oval test track consists of three lanes of asphalt road surface designed to carry loads up to 32,000 pounds per axle. Each lane has specific uses designed to maximize track utility and safety.

Should test procedures require speeds greater than 90 mph in the straights or 80 mph in the corners, special precautions in the form of exclusive track use, competition seat belts, strobe lights, and roll bars may be required.

The oval is used for a wide variety of tests and subjective evaluations, as well as general pre-test warm-ups and conditioning work. Its limited-access feature allows engineers and technicians to concentrate on subtle NVH and ride/handling problems as required. In special cases, the oval can be closed to other traffic to accommodate unusual events, such as EPA coast down tests.

The west straight, south curve, and east straight are each 4,220 feet long (0.8 mi), with only the north curve measuring a shorter 3,170 feet long (0.6 mi). Because of its extremely flat profile, most brake testing is performed on the east straight. All lanes measure 12 feet wide.



TESTING **FACILITIES**

HIGH-SPEED OVAL TRACK

Oval Track Data						
Lane	inside		center		outside	
Allowable Speed Range (mph)	0-40		41-70		71&up	
Bank Angle	S	N	S	N	S	N
Degrees	6.8	8.8	10.1	12.8	13.8	17.3
Percent	11.9	15.5	17.8	22.7	24.6	31.7
Radius (ft)	1129	883	1141	895	1153	907
Neutral Speed (mph)	45		55		65	





TESTING **FACILITIES**

VEHICLE DYNAMICS AREA ONE (SMALL VDA)

The vehicle-dynamics area (VDA), or small skid pad, is roughly trapezoidal shaped with an overall length of 1,400 feet and major width of 300 feet.

A variety of braking road surfaces with different coefficients of friction are available, as well as a high coefficient asphalt area that is suitable for “braking in a curve” maneuvers, J-turns, figure 8’s, and tight-radius lateral-acceleration tests.

The test surfaces and their peak/slide coefficients are listed on the drawing on the following page.

A fully instrumented skid trailer also ensures that paved surfaces are of known traction coefficients.

High-coefficient asphalt and various low-coefficient (wetted) surfaces for ABS testing.

TESTING FACILITIES

VEHICLE DYNAMICS AREA TWO (LARGE VDA)

Measuring 550 feet by 530 feet plus re-entry lane for establishing test maneuver speeds

Total length: 1375 feet.

Surface coefficient: PFC is 0.9 with less than 1% slope

1 – 150 ft radius to the center of the 12 or 14 ft lane J-Turn for FMVSS 136 Electronic Stability Control Compliance for Tractors and Buses

1 – 150 ft radius circle for constant radius and/or decreasing radius stability performance maneuvers

Highway/City lane line markings for conducting the following maneuvers:

- Lane Departure Warning (LDW) Test
- Road Departure Braking (RDB) Test
- Collision Mitigation System Stationary Object 'Simulated Vehicle – Soft Target' Test
- Collision Mitigation System Stationary and Moving Vulnerable Road User Detection
- (VRUD) Object 'Simulated Pedestrian' – Soft Target Testing



TESTING **FACILITIES**

UNPAVED ROADS/OFF-ROAD CONDITIONS

“D” roads are graded, compacted-gravel roads with both sweeping right and left-hand turns.

“M” roads are unimproved and ungraded combinations of clay, sand and gravel surfaces.

Grades range from 3% to 30% and include some drainage culverts. “M” roads have a military focus/off-road applicability.

GRADES:

(length x width)

- 15% (112' x 12')
- 20% (151' x 14')
- 30% (86'x12')
- 60% (55'x12')



TESTING FACILITIES

WATER BASIN

252 feet long by 20 feet wide is available for accelerated corrosion testing, water-intrusion evaluation, and brake soaking.

Either pure water or salt-water solutions are available.

The drive-through maximum depth is 64 inches, although damming can increase the fording limit to 84 inches.



**WATER
BASIN**

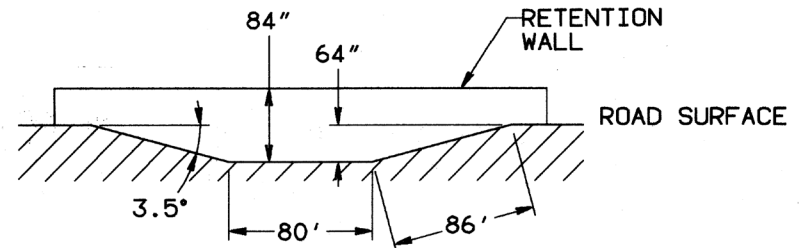

TESTING **FACILITIES**

LOW-COEFFICIENT TRACTION-CONTROL SURFACES

Level, 12% and 15% grades are available for traction control evaluation.

The surface is wetted with a soap-water solution to allow split-mu (low-coefficient/high-coefficient) traction-control development work.



STRUCTURAL DURABILITY EVENTS



Accelerated mileage-accumulation structural-durability testing occurs over a variety of durability events. These durability event road surfaces are designed to provide vehicle chassis inputs to simulate real world inputs. This allows a test of only a few weeks or months to represent the total mileage that a vehicle would experience in its' lifetime.

Specific correlation of a customer's typical operating environment to a NPG accelerated structural durability procedure can be provided by NPG through a road profile determination. Accelerometer and strain gage data is gathered over both the road surfaces typically encountered during the vehicle's life and the NPG durability events. The data is then analyzed generating correlation of accelerated test miles to "real world" miles for the specific components measured.

INVERTED CHATTER BUMPS

Five sets of inverted chatter bumps, with 10 bumps in each set, are placed along road A-1. These depressions measure 1 inch deep by 24 inches long, and are spaced from 5 feet to 9 feet apart.

Event width measures 12 feet. An average of 350 feet of recovery area follows each set of bumps.

Depending on speed and vehicle type, chatter bumps provide moderate to severe vertical accelerations. When combined with A-1 grades as steep as 14% uphill and 12% downhill, they can also input large pitching moments and fore/aft accelerations into the vehicle.

**INVERTED
CHATTER
BUMPS**

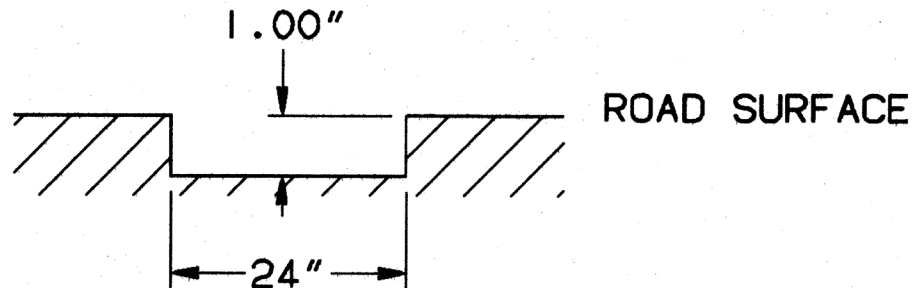

PAVED ROAD DURABILITY EVENTS

IMPACT BUMPS

A total of 66 concrete impact bumps measuring 1.25 inches high by 18 inches long and shared between two wheel paths 500' long. The bumps are staggered wheel path to wheel path (providing a bending input to both front and rear suspensions) with a variable longitudinal spacing of 10 feet to 20 feet. Impact bumps provide a severe vertical acceleration into a vehicle structure.



IMPACT BUMPS

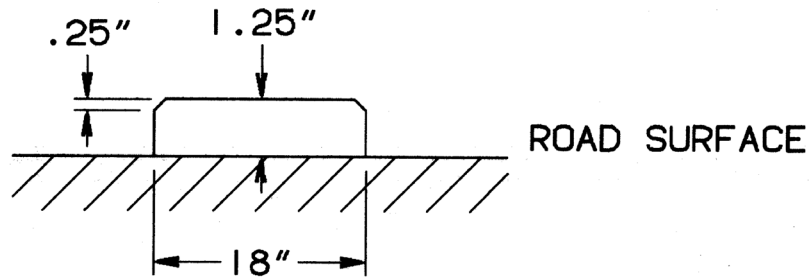

PAVED ROAD DURABILITY EVENTS



CHATTER BUMPS

The chatter bump event is 270 feet long. The bumps are .75 inches high by 15 inches wide with a peak-to-peak distance of approximately 42 inches and a bump-to-road axis angle of 75 degrees.

Vertical acceleration inputs are small, but the frequency of those excitations is high, making this course useful for NVH development work.

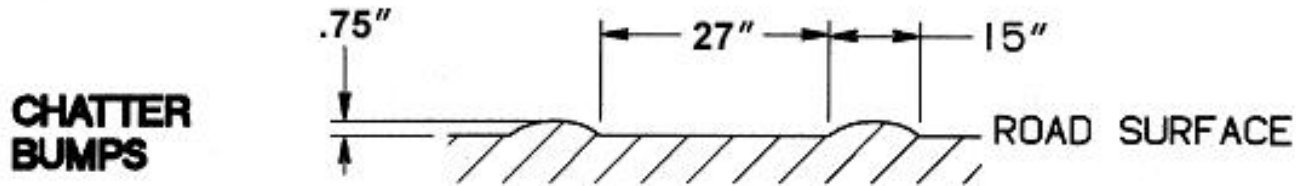

ROAD AXIS TO BUMP AXIS ANGLE OF 75°

PAVED ROAD DURABILITY EVENTS

COBBLESTONES

LIGHT-VEHICLE / HEAVY-VEHICLE

The light & heavy vehicle cobblestone events are each 500' long. The distance between boulders averages 5 inches. The maximum heights for the light-vehicle and heavy-vehicle events are 3 inches and 5 inches, respectively.

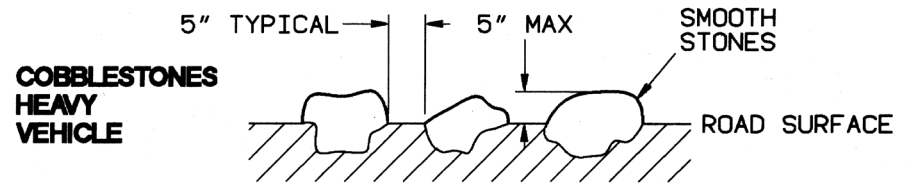
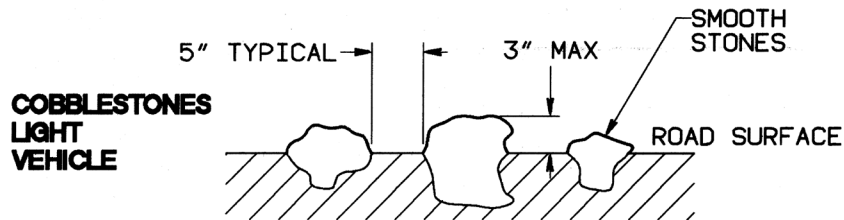

PAVED ROAD DURABILITY EVENTS



CHUCKHOLE

A single-wheel chuckhole, measuring 4 feet long by 8 feet wide by 4.5 inches deep, provides maximum acceleration impacts for severe-duty suspension testing.

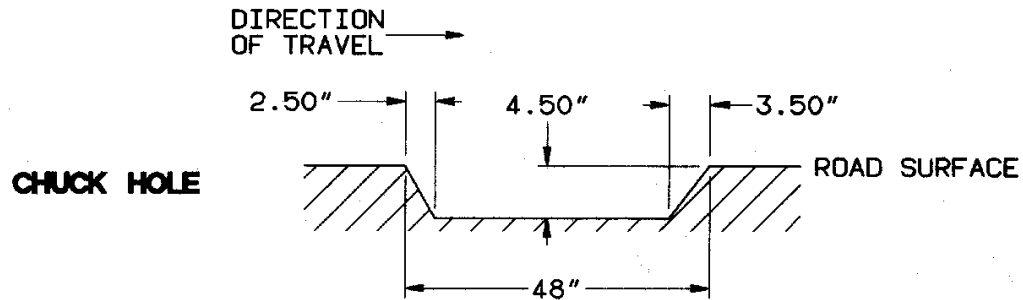

PAVED ROAD DURABILITY EVENTS

UNDULATING ROAD

There are two 1,500-foot-long asphalt vibration roads designed to produce resonant frequency un-damped vibration in chassis systems. The frequency and amplitude of the bumps are designed so that a typical vehicle traversing the event at roughly 20 mph will exhibit ever-increasing fore/aft pitching, yielding very high suspension deflections.



**UNDULATING
ROAD**

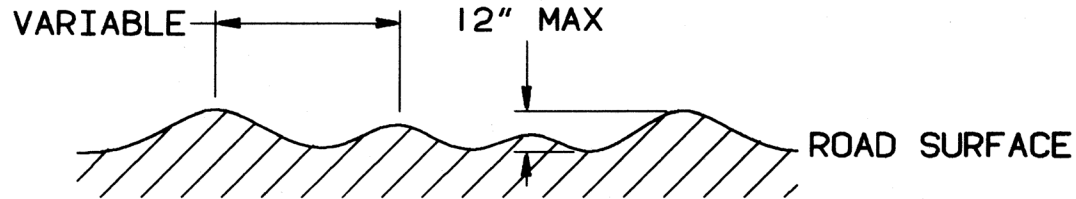

PAVED ROAD DURABILITY EVENTS



RESONANCE ROAD

The 1,600-foot-long resonance road has a variable distance between bumps of 42" to 114".

Each bump is 0.875 inches high by 18 inches long and is oriented in 10 different 10° and 15° angle steps from the roadway axis along its entire length.

A total of 247 bumps are included in each wheel path.

**RESONANCE
ROAD**

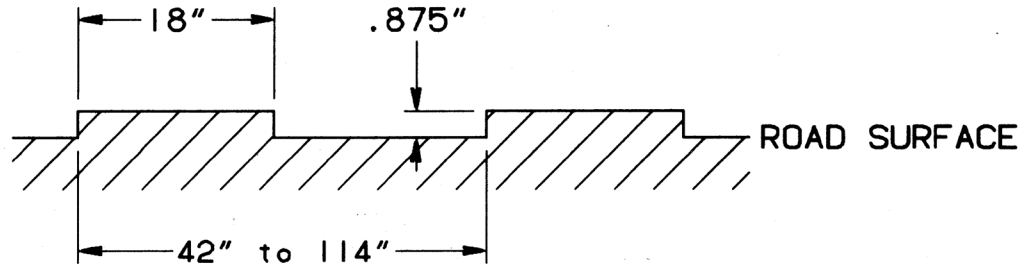

ROAD AXIS TO BUMP AXIS ANGLES OF 45° - 135°

PAVED ROAD DURABILITY EVENTS

STAGGERED BUMPS FOR CHASSIS TORSION

Just preceding the staggered bumps is a single, full-width suspension-setting bump, measuring 6 inches high by 23 feet long, which is designed to stabilize and equalize suspension components. Six staggered bumps, measuring 6 inches high by 16 feet long, are strategically placed over a 126-foot-long path to torsionally twist trailer and vehicle frames and body structures in both clockwise and counterclockwise directions.



STAGGERED BUMPS

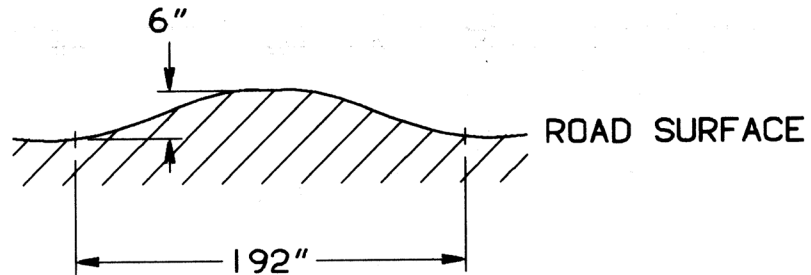

PAVED ROAD DURABILITY EVENTS

WAKE-UP STRIPS

Milled into the asphalt on the south end of the A-5 road are “wake up” strips measuring 4 inches wide by 0.5 inch deep.

These small ripples are copies of the toll-booth approach wake-up alarms typically found on I-294 in Chicago and on many interstate toll roads

WAKE UP STRIPS

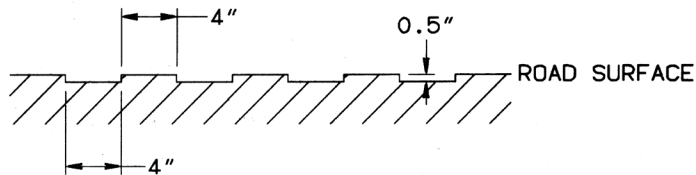

SUSPENSION-BOTTOMING BUMP

Just west of the B-4/A-4 intersection is a constant-radius concave concrete bump that is 3.5 inches deep.

From beginning to end the event is slightly over 13 feet long and 7.5 feet wide.

BOTTOMING BUMP

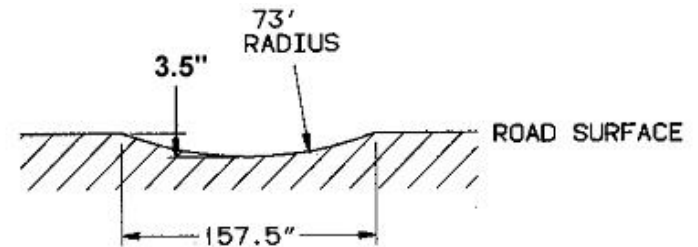

“ALTOONA” TEST TRACK

This is a duplication of the “Altoona” Pennsylvania Test route. This route allows bus manufacturers to pre-test prior to validation testing at the Altoona test facility.

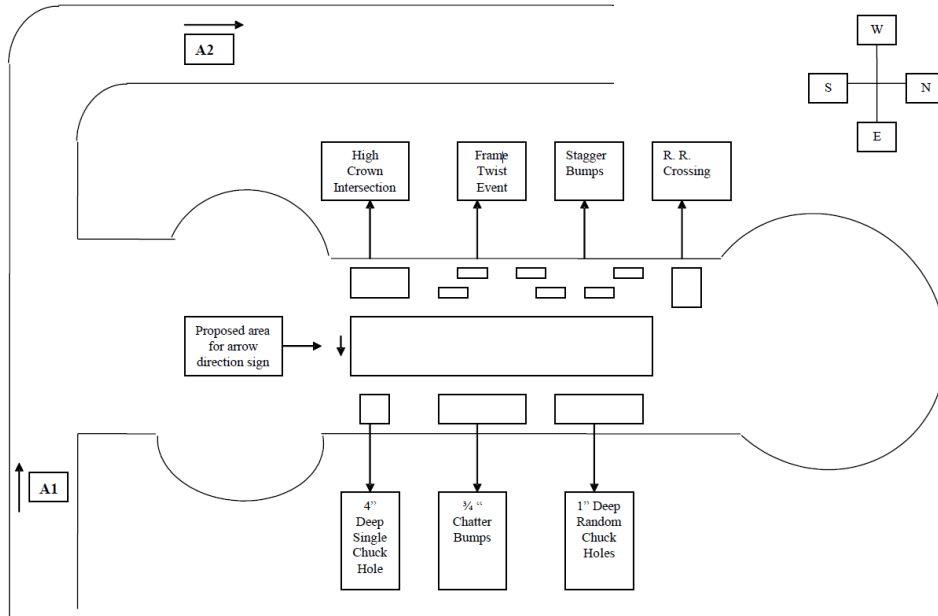

STAGGER BUMPS



FRAME TWIST



HIGH CROWN INTERSECTION



RR CROSSING

LOOKING NORTH



LOOKING SOUTH



DEEP RANDOM CHUCKHOLES



$\frac{3}{4}$ " CHATTER BUMPS

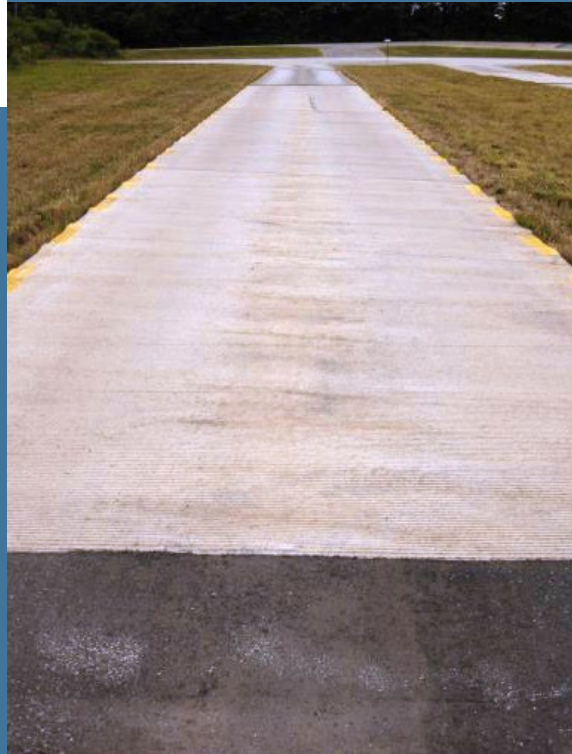

4" DEEP SINGLE CHUCKHOLE





NPG GARAGE AREAS, SUPPORT EQUIPMENT & INSTRUMENTATION

There is a total of **88,000** square feet of garage and office area.

FACILITIES

- **CUSTOMER GARAGES**

Dedicated customer garages with special security features are available as required for both passenger cars and large vehicles.

- **MACHINE SHOP**

Fully equipped shop for metal working & welding.

- **FUELING CAPABILITIES**

Diesel, DEF, Gasoline, CNG, Propane, Hydrogen & EV Charging Stations

- **WASH BAY**

A drive-through wash bay, capable of holding heavy trucks, trailers and large buses is equipped with a high-pressure power washer. This capability enhances vehicle inspections.

- **TOOL CRIB**

A fully stocked tool crib with a wide variety of hardware, fittings, specialized tools and general supplies is located on site for the convenience and efficiency of our customers and staff

SUPPORT EQUIPMENT

- Truck scales.
- Electronic light-vehicle scales.
- Wheel alignment equipment.
- Overhead cranes.



CUSTOMER USE OF **NPG**

DEMONSTRATIONS

- The NPG facility is available for customer sales or performance demonstrations.

DRIVING PRIVILEGES

- Only approved NPG drivers may operate a vehicle on grounds. To support the need for visiting personnel to perform vehicle evaluations, on-site guests may drive on the facility if accompanied by a NPG driver. In special cases, customers can obtain driving privileges.

AXLE WEIGHTS

- Weights are limited to 32,000 pounds per axle. April time period axle weights can be limited to 10,000 pounds during a thaw period.